



# Technical Data Sheet

## Opto Interrupter

### ITR20002-A

#### ■ Features

- Fast response time
- High analytic
- High sensitivity
- Cut-off visible wavelength  $\lambda_p=940\text{nm}$
- Pb free
- This product itself will remain within RoHS compliant version.

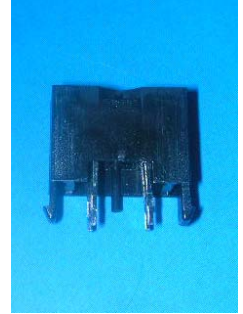

#### ■ Descriptions

The **ITR20002-A** consist of an infrared emitting diode and an NPN silicon phototransistor, encased side-by-side on converging optical axis in a black thermoplastic housing. The phototransistor receives radiation from the IR only . This is the normal situation. But when an reflecting object close to ITR , phototransistor receives the reflecting radiation .For additional component information, please refer to IR4204-10 and PT4204-6B/H26.

#### ■ Applications

- Mouse Copier
- Switch Scanner
- Floppy disk driver
- Non-contact Switching
- For Direct Board

#### ■ Device Selection Guide

Device No.	Chip Material	LENS COLOR
IR4204-10	GaAlAs	Blue
PT4204-6B/H26	Silicon	Black

**Package Dimensions**

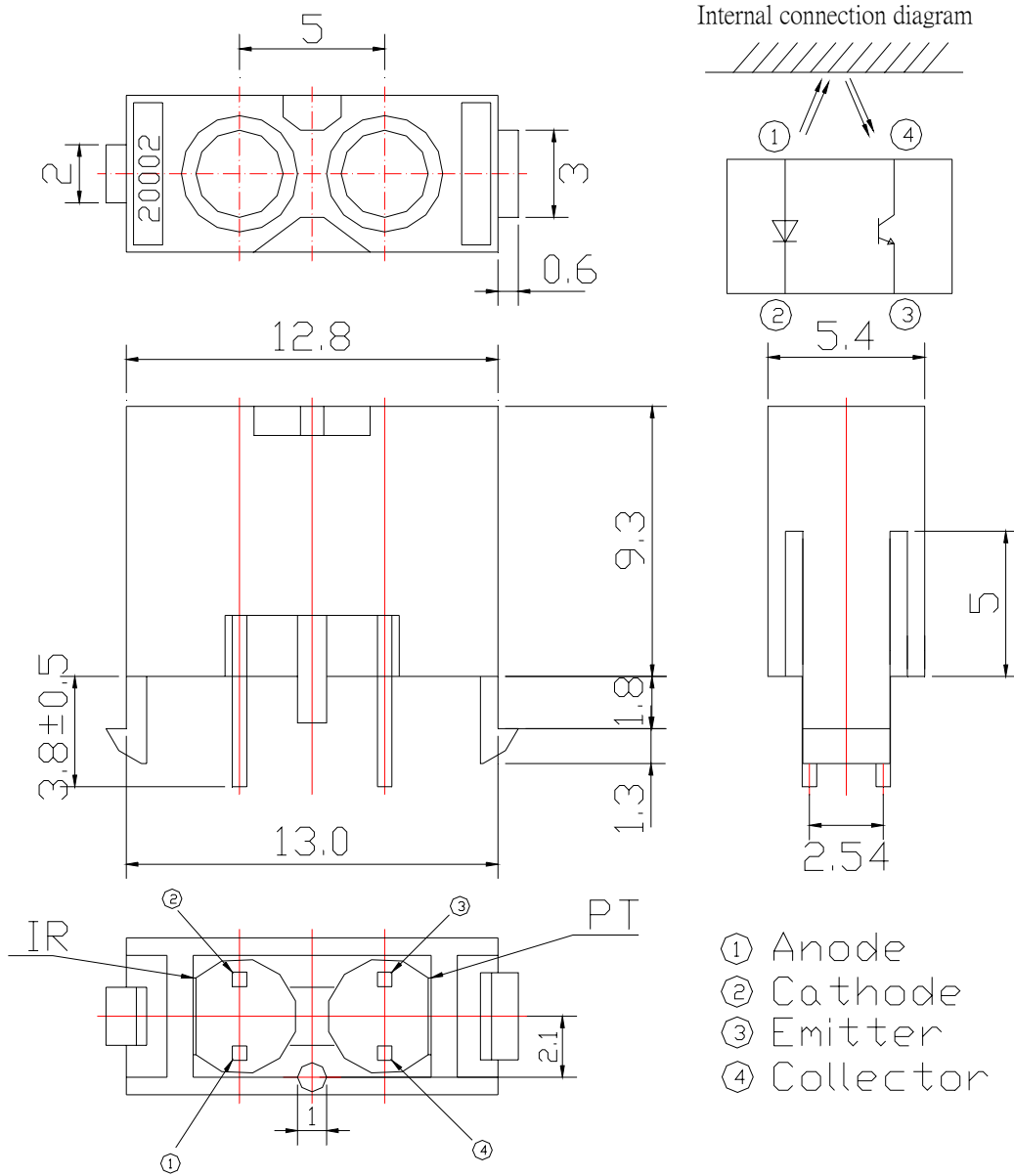

1. All dimensions are in millimeters
2. Tolerances unless dimensions  $\pm 0.3$ mm
3. Lead spacing is measured where the lead emerge from the package

**Absolute Maximum Ratings (Ta=25°C)**

Parameter		Symbol	Ratings	Unit
Input	Power Dissipation at(or below) 25°C Free Air Temperature	Pd	75	mW
	Reverse Voltage	V <sub>R</sub>	5	V
	Forward Current	I <sub>F</sub>	50	mA
	Peak Forward Current (*1) Pulse width ≤ 100 μs, Duty cycle=1%	I <sub>FP</sub>	1	A
Output	Collector Power Dissipation	P <sub>C</sub>	75	mW
	Collector Current	I <sub>C</sub>	20	mA
	Collector-Emitter Voltage	B V <sub>CEO</sub>	30	V
	Emitter-Collector Voltage	B V <sub>ECO</sub>	5	V
Operating Temperature		T <sub>opr</sub>	-40~+85	°C
Storage Temperature		T <sub>stg</sub>	-40~+85	°C
Lead Soldering Temperature (*2) (1/16 inch form body for 5 seconds)		T <sub>sol</sub>	260	°C

(\*1)  $t_w=100 \mu \text{sec.}$ ,  $T=10 \text{msec.}$  (\*2)  $t=5 \text{Sec}$

**Electro-Optical Characteristics (Ta=25°C)**

Parameter		Symbol	Min.	Typ.	Max.	Unit	Condition
Input	Forward Voltage	V <sub>F</sub>	-	1.2	1.5	V	I <sub>F</sub> =20mA
	Reverse Current	I <sub>R</sub>	-	-	10	μA	V <sub>R</sub> =5V
	Peak Wavelength	λ <sub>P</sub>	-	940	-	nm	I <sub>F</sub> =20mA
	View Angle	2θ 1/2	-	35	-	Deg	I <sub>F</sub> =20mA
Output	Dark Current	I <sub>CEO</sub>	-	-	100	nA	V <sub>CE</sub> =20V, E <sub>e</sub> =0mW/cm <sup>2</sup>
	C-E Saturation Voltage	V <sub>CE(sat)</sub>	-	-	0.4	V	I <sub>C</sub> =0.04mA, I <sub>F</sub> =40mA
Collector Current(*3)		I <sub>C(ON)</sub>	150	-	-	μA	V <sub>CE</sub> =5V, I <sub>F</sub> =20mA
		I <sub>C(OFF)</sub>	-	-	30		
Response Time	Rise Time	t <sub>R</sub>	-	15	-	μs	V <sub>CE</sub> =5V, I <sub>C</sub> =100 μA , R <sub>L</sub> =100Ω
	Fall Time	t <sub>F</sub>	-	15	-		

(\*3) I<sub>C(on)</sub> at the testing condition—with reflector in 6mm away,

I<sub>C(off)</sub> at the testing condition—without reflector and external light less than 10 Lux at the module surface.

**Typical Electrical/Optical/Characteristics Curves for IR**

Fig. 1 Forward Current vs. Ambient Temperature

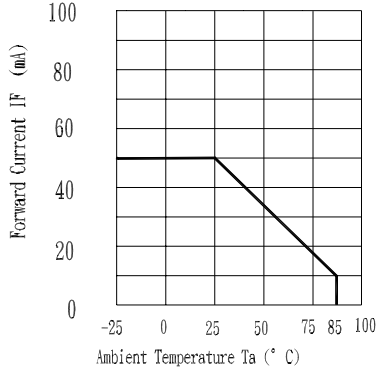

Fig. 2 Spectral Distribution

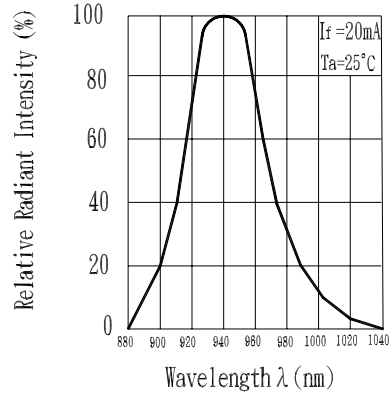

Fig. 3 Peak Emission Wavelength vs. Ambient Temperature

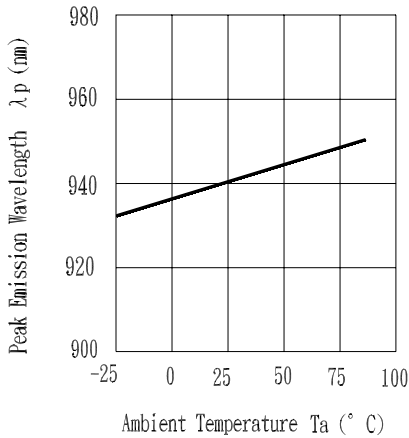

Fig. 4 Forward Current vs. Forward Voltage

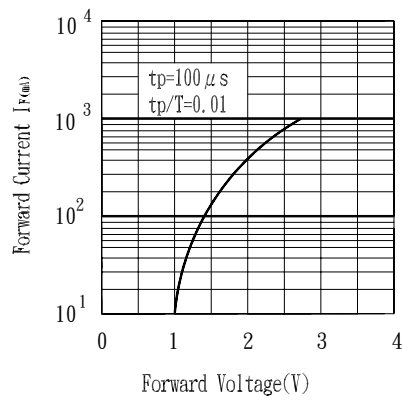

Fig. 5 Relative Intensity vs. Forward Current

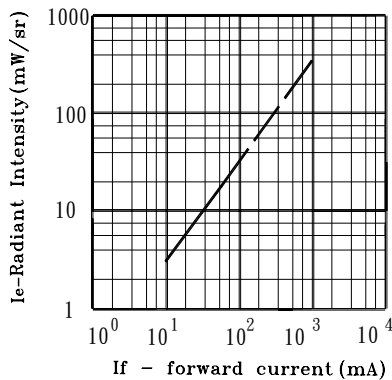
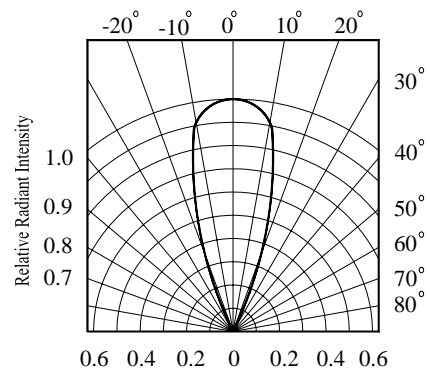
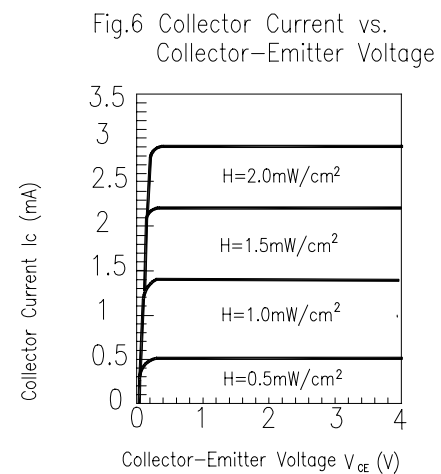
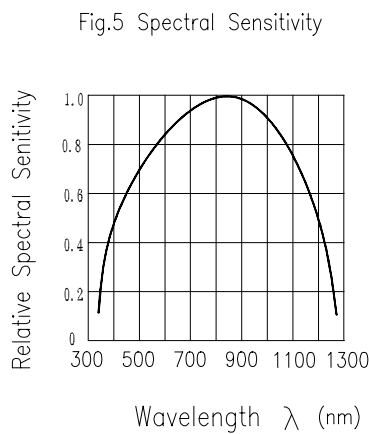
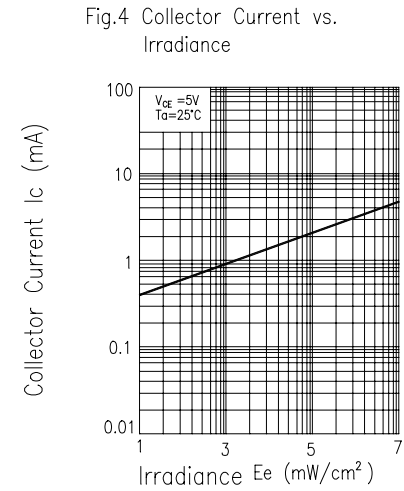
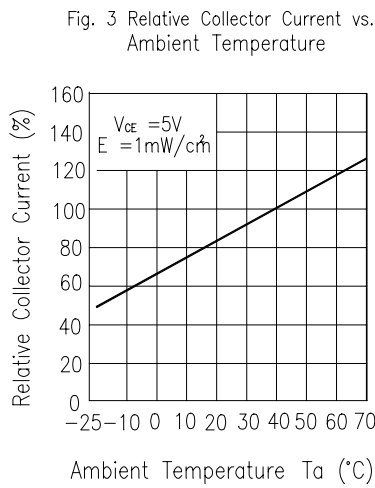
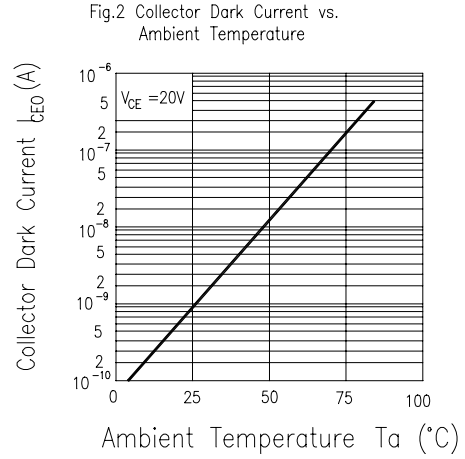
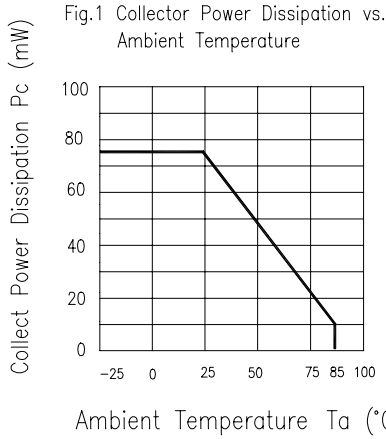

Fig. 6 Relative Radiant Intensity vs. Angular Displacement



**Typical Electrical/Optical/Characteristics Curves for PT**



**Reliability Test Item And Condition**

The reliability of products shall be satisfied with items listed below.

Confidence level : 90%

LTPD : 10%

NO.	Item	Test Condition	Test Hours/ Cycle	Sample Size	Failure Judgement Criteria	Ac/Re
1	Solder Heat	TEMP : 260°C ± 5 °C	5 sec	22 PCs	$I_{c(on)} \leq L \times 0.8$  L : Lower specification limit	0/1
2	Temperature Cycle	H : +100°C    15 mins ⇕ 5 min L : -40°C    15 min	300 cycle	22 PCs		0/1
3	Thermal Shock	H : +100°C    5 min ⇕ 10 sec L : -10°C    5 min	300 cycle	22 PCs		0/1
4	High Temperature Storage	TEMP. : +100°C	1000 hrs	22 PCs		0/1
5	Low Temperature Storage	TEMP. : -40°C	1000 hrs	22 PCs		0/1
6	DC Operating Life	$V_{ce}=5V$ $I_f=20mA$	1000 hrs	22 PCs		0/1
7	High Temperature / High Humidity	85°C / 85% R.H.	1000 hrs	22 PCs		0/1



## ITR20002-A

### Packing Quantity Specification

- 1.150PCS/1Bag, 5Bag/1Box
2. 10Boxes/1Carton

### Label Form Specification

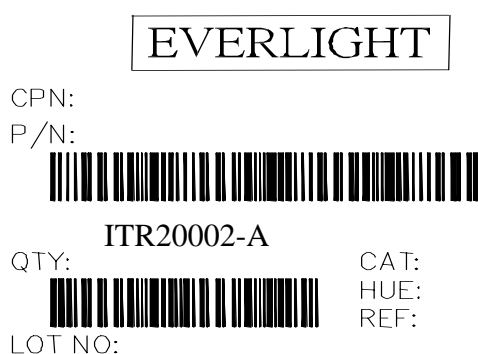

CPN: Customer's Production Number  
P/N : Production Number  
QTY: Packing Quantity  
CAT: Ranks  
HUE: Peak Wavelength  
REF: Reference  
LOT No: Lot Number

### Notes

1. Above specification may be changed without notice. EVERLIGHT will reserve authority on material change for above specification
2. These specification sheets include materials protected under copyright of EVERLIGHT corporation . Please don' t reproduce or cause anyone to reproduce them without EVERLIGHT' s consent
3. When using this product , please observe the absolute maximum ratings and the instructions for use outlined in these specification sheets. EVERLIGHT assumes no responsibility for any damage resulting from use of the product which does not comply with the absolute maximum ratings and the instructions included in these specification sheets.

**EVERLIGHT ELECTRONICS CO., LTD.**  
Office: No 25, Lane 76, Sec 3, Chung Yang Rd,  
Tucheng, Taipei 236, Taiwan, R.O.C

Tel: 886-2-2267-2000, 2267-9936  
Fax: 886-2267-6244, 2267-6189, 2267-6306  
<http://www.everlight.com>